

DayBreak

by WESLO®

Model No. QVRX10170

Serial No. _____

Write the serial number in the space above for reference.

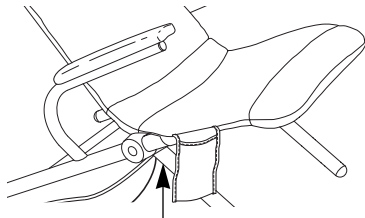

Serial Number Decal (On Frame)

QUESTIONS?

As a manufacturer, we are committed to providing complete customer satisfaction. If you have questions, or find that there are missing parts, we will guarantee complete satisfaction through direct assistance from our factory.

TO AVOID UNNECESSARY DELAYS, PLEASE CALL DIRECT TO OUR TOLL-FREE CUSTOMER HOT LINE. The trained technicians on our customer hot line will provide immediate assistance, free of charge to you.

CUSTOMER HOT LINE:

1-800-999-3756

Mon.–Fri., 6 a.m.–6 p.m. MST

CAUTION

Read all precautions and instructions in this manual before using this equipment. Save this manual for future reference.



Patent Pending

USER'S MANUAL



DayBreak

by WESLO®

TABLE OF CONTENTS

| | |
|--|-------------|
| IMPORTANT PRECAUTIONS | .3 |
| BEFORE YOU BEGIN | .4 |
| ASSEMBLY | .5 |
| HOW TO OPERATE THE MASSAGE CHAIR | .6 |
| MAINTENANCE AND STORAGE | .9 |
| PART LIST | .10 |
| EXPLODED DRAWING | .11 |
| HOW TO ORDER REPLACEMENT PARTS | .Back Cover |
| LIMITED WARRANTY | .Back Cover |

IMPORTANT PRECAUTIONS

WARNING: To reduce the risk of burns, fire, electric shock, or serious injury to persons, read all important precautions before using the massage chair.

READ AND FOLLOW ALL INSTRUCTIONS

1. Read all precautions and instructions in this manual before using the massage chair.
2. It is the responsibility of the owner to ensure that all users of the massage chair are adequately informed of all precautions.

DANGER

To reduce the risk of electric shock:

3. Always turn off the hand control and unplug the power cord from the outlet immediately after using and before cleaning the massage chair.

WARNING

To reduce the risk of burns, fire, electric shock, or injury to persons:

4. Never leave the massage chair unattended while it is plugged in.
5. Do not use the massage chair under a blanket or pillow. Excessive heating can occur and cause fire, electric shock, or injury to persons.
6. Close supervision is necessary when the massage chair is used by, on, or near invalids or disabled persons.
7. Keep children away from the massage chair.
8. Use the massage chair only for its intended use as described in this manual.
9. Never operate the massage chair if it is not working properly, if it is damaged, or if the power cord or plug is damaged. If any of

these conditions exists, call the toll-free telephone number on the front of this manual.

10. Keep the power cord away from heated surfaces.
11. Use the massage chair indoors. Never use the massage chair outdoors.
12. The massage chair is intended for home use only. Do not use the massage chair in a commercial, rental, or institutional setting.

DANGER

13. Keep pins and other sharp objects away from the massage chair.
14. Carefully examine the massage chair before each use. If there are any signs of deterioration, call the toll-free telephone number on the front of this manual.
15. Keep the massage chair dry, away from water and moisture.

WARNING

16. Temperatures sufficiently high to cause burns may occur. Do not use on an infant or invalid or on a sleeping or unconscious person. Do not use on insensitive skin or on a person with poor blood circulation. Check the skin in contact with the heated area of the massage chair frequently to reduce the risk of blistering.
17. Do not crush the massage chair. Avoid sharp folds in the massage pad.

WARNING: Read all instructions before using this product. ICON assumes no responsibility for personal injury or property damage sustained by or through the use of this product.

SAVE THESE INSTRUCTIONS

BEFORE YOU BEGIN

Congratulations for selecting the DAYBREAK multi-zone massage chair by WESLO®. The innovative DAYBREAK is designed to melt away stress—relaxing you, stimulating circulation, and reducing muscle fatigue—any time you choose. Using the convenient hand control, you can choose upper-back, lower-back, or thigh massage, wave or pulse motion, or the built-in heater. You can even remove the massage pad from the frame and use it on the floor or a bed. And when the massage chair is not in use, it can be folded for compact storage, so you can take it wherever there is an electrical outlet!

reading this manual, call our Customer Service Department toll-free at 1-800-999-3756, Monday through Friday, 6 a.m. until 6 p.m. Mountain Time (excluding holidays). Before calling, please note the product model number and serial number. The model number is QVRX10170. The serial number can be found on a decal attached to the frame (see the front cover of this manual).

Before you assemble the DAYBREAK, please look at the drawing below and familiarize yourself with the parts that are labeled.

For your benefit, read this manual carefully before using the DAYBREAK. If you have questions after

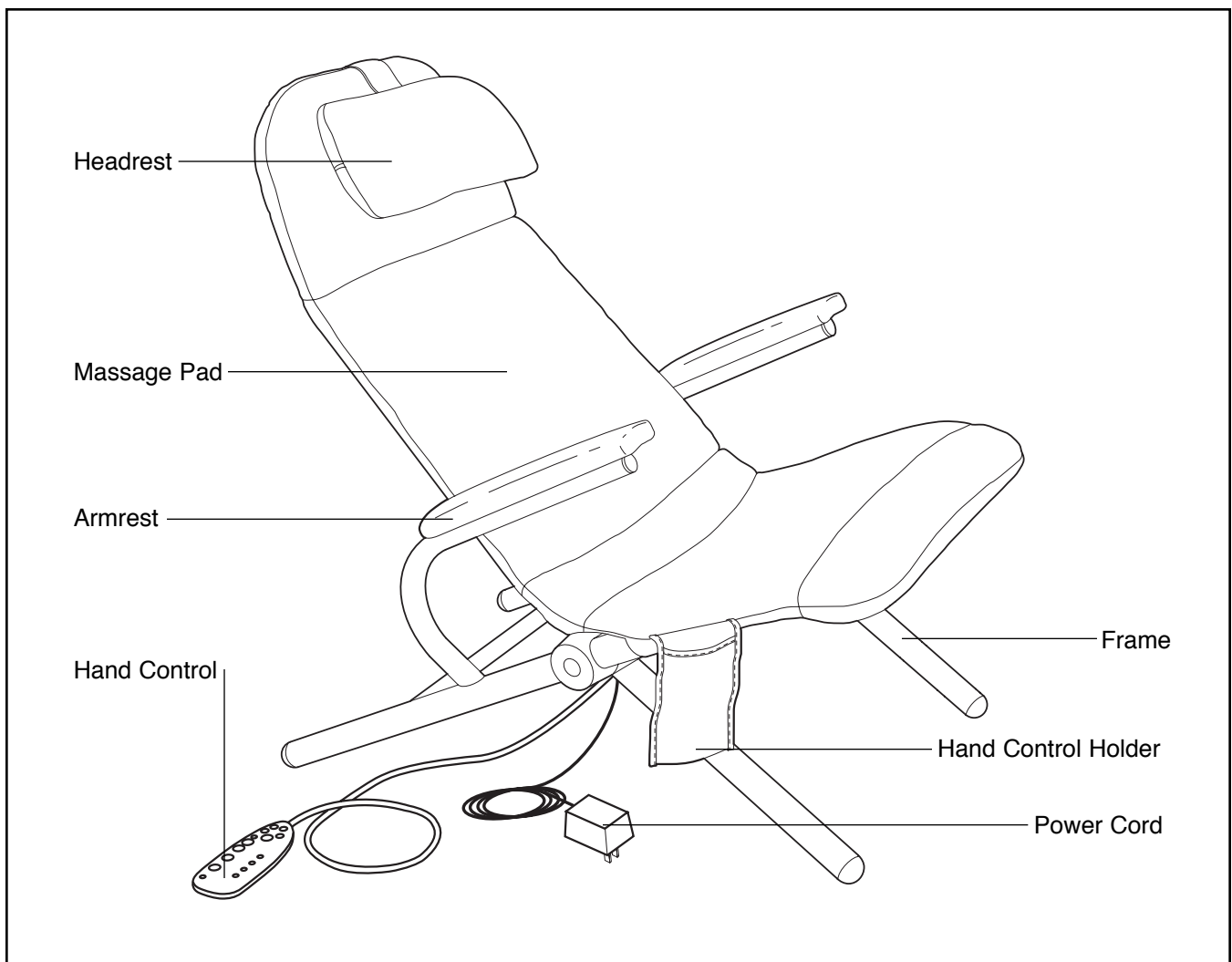

ASSEMBLY

Place all parts of the DAYBREAK in a cleared area and remove the packing materials; do not dispose of the packing materials until the DAYBREAK is fully assembled. For your convenience, the DAYBREAK can be assembled in four simple steps. **An adjustable wrench**  (not included) is required.

1. Unfold the massage chair to the position shown at the right. Make sure that the Massage Pad (12) is correctly positioned on the Seat Frame (10) and Back Frame (15).

Press one of the Pivot Covers (7) onto the Seat Frame (10). Make sure that the Pivot Cover is turned so the plastic pin inside the Pivot Cover snaps into the indicated hole. Reach under the Massage Pad (12) and press another Pivot Cover (7) onto the Back Frame (15).

Attach the other two Pivot Covers (7) to the opposite side of the DAYBREAK in the same manner (not shown).

2. Attach one of the Arms (9) to the Seat Frame (10) with two 5/16" x 2" Carriage Bolts (1), two 5/16" Washers (4), and two 5/16" Nylon Locknuts (5) as shown.

Attach the other Arm (9) to the Seat Frame (10) in the same manner.

3. Connect the wire harness on the Hand Control (14) to the wire harness on the Massage Pad (12). Refer to the inset drawing. Make sure that the indicated latch on the wire harness is engaged. **If the wire harnesses do not fit together easily, turn them. Do not force the wire harnesses together.**

4. Plug the Power Cord (16) into the jack on the Massage Pad (12).

Make sure that all parts of the massage chair are properly tightened.

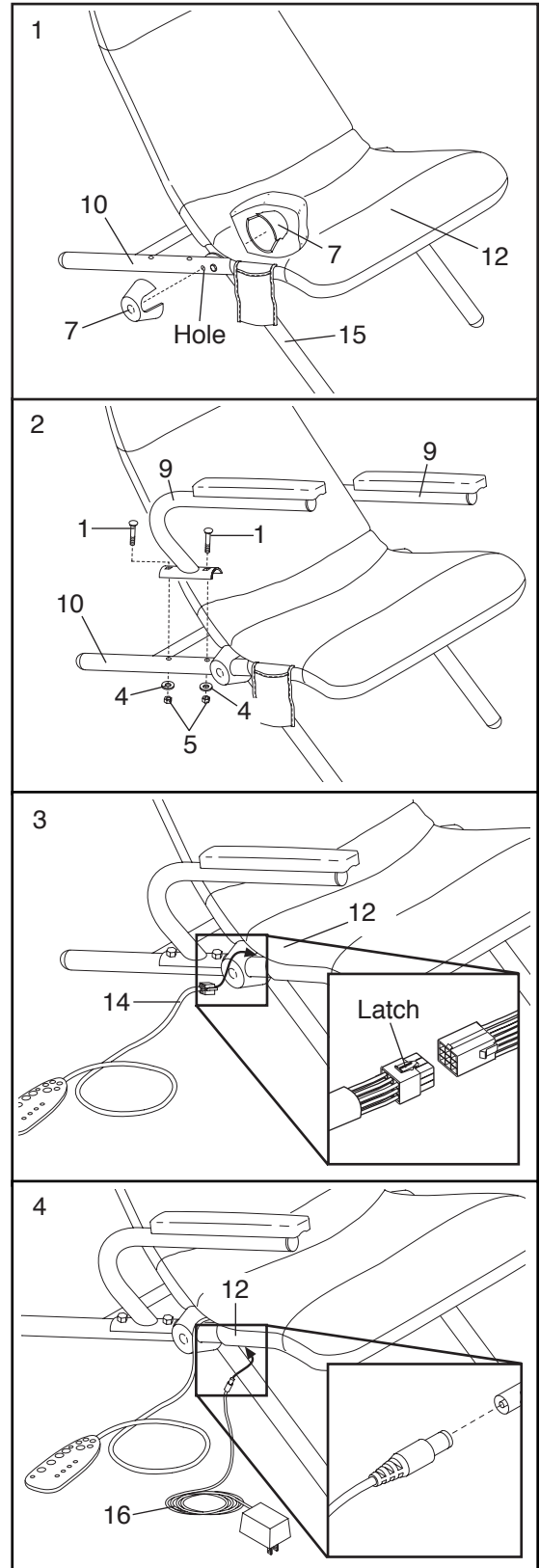

HOW TO OPERATE THE MASSAGE CHAIR

DIAGRAM OF THE HAND CONTROL

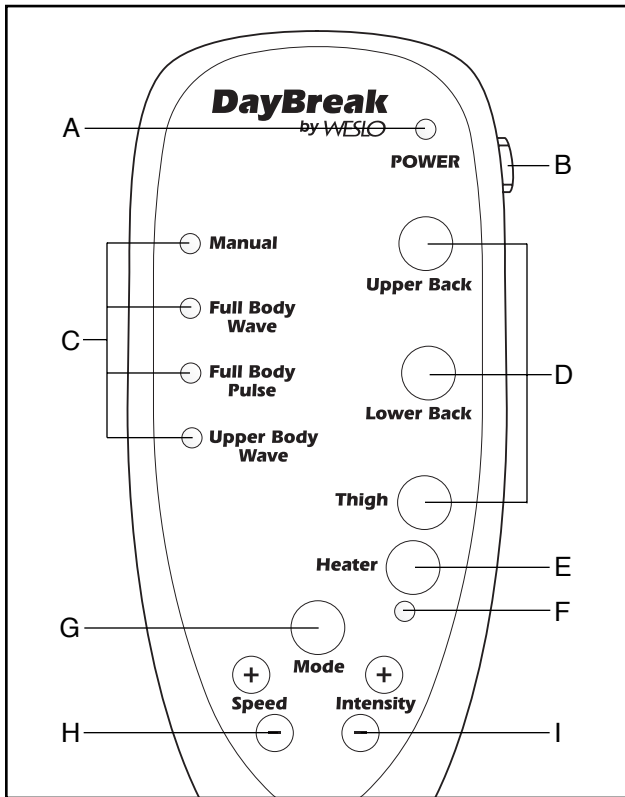

- A. Power Indicator—This indicator lights when the power is on.
- B. Power Switch—This switch turns the power on and off.
- C. Mode Indicators—These indicators show which mode is selected.
- D. Upper Back, Lower Back, and Thigh Buttons—When the Manual mode is selected, these buttons activate the three massage zones.
- E. Heater Button—This button turns the built-in heater on and off.
- F. Heater Indicator—This indicator lights when the built-in heater is on.
- G. Mode Button—This button selects the four modes.
- H. Speed Buttons—These buttons control the speed of the massage action when one of the three automatic modes is selected.
- I. Intensity Buttons—These buttons control the intensity of the massage action in all modes.

FEATURES OF THE MASSAGE CHAIR

The convenient hand control lets you customize the type of massage you get each time you use the massage chair. With the manual mode selected, you can choose any combination of upper-back, lower-back, and thigh massage action. If desired, the built-in heater can be turned on. The control also offers three automatic modes: Full Body Wave, Full Body Pulse, and Upper Body Wave. Whichever mode you choose, the speed and intensity of the massage action can be adjusted to the level that's just right for you.

HOW TO USE THE HAND CONTROL

To use the massage chair, first plug the transformer on the power cord into a 120-volt outlet. Keep the power cord away from walkways and heated surfaces.

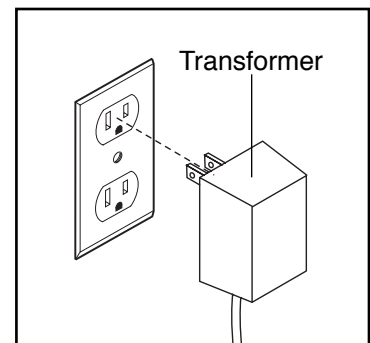

Next, sit on the massage chair and relax. Follow the steps below to use the hand control.

HOW TO TURN ON THE POWER

Slide the power switch to the "on" position; the power indicator will light. Note: If there is a thin sheet of clear plastic on the face of the hand control, remove it.

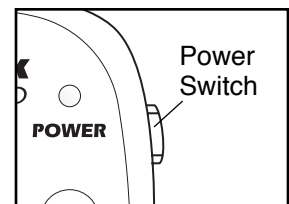

HOW TO USE THE MANUAL MODE

1. When the power is turned on, the Manual mode will be selected and the Manual mode indicator will light. Note: If a different mode is selected, press the Mode button repeatedly until the Manual mode indicator lights.

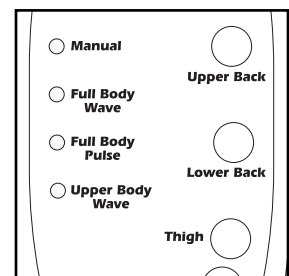

- The massage chair features three separate massage zones: the upper back, lower back, and thigh zones.

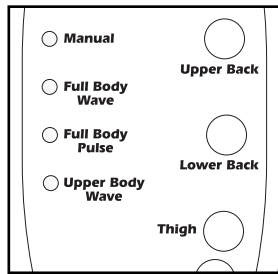

The massage zones are controlled with the Upper Back, Lower Back, and Thigh buttons. Pressing a button once will activate a massage zone. Pressing the button again will turn off the massage zone. Press the buttons to activate the desired massage zones.

- After you have activated the desired massage zones, press the Intensity + or - buttons to adjust the intensity of the vibrating massage action.

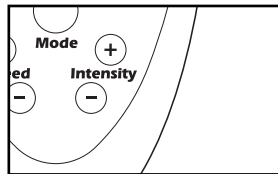

Note: If no buttons on the hand control are pressed for twenty minutes, the vibrating massage action will automatically stop. To restart the massage action, follow steps 1 through 3 above.

HOW TO USE THE AUTOMATIC MODES (FULL BODY WAVE, FULL BODY PULSE, AND UPPER BODY WAVE)

- Press the Mode button repeatedly to select the desired mode. A mode indicator will light to show which mode is selected.

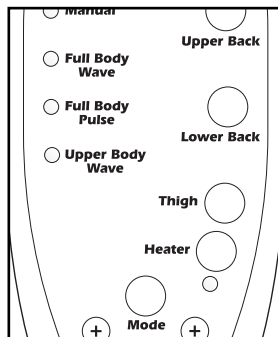

When Full Body Wave is selected, the upper body, lower body, and thigh zones will be activated in sequence, producing a wave-like massage motion. When Full Body Pulse is selected, the upper body, lower body, and thigh zones will be activated together with a pulsing motion. The Upper Body Wave is similar to the Full Body Wave, but only the upper body and lower body zones will be activated.

- After you have selected the desired mode, press the Speed and Intensity buttons to adjust the speed and intensity of the vibrating massage action.

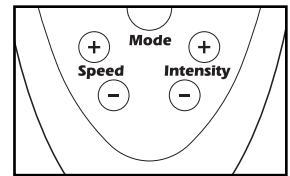

Note: If no buttons on the hand control are pressed for twenty minutes, the vibrating massage action will automatically stop. To restart the massage action, follow steps 1 and 2 above.

HOW TO ACTIVATE THE BUILT-IN HEATER

Whether the Manual mode or one of the automatic modes is selected, you can add soothing heat to your massage, if desired. To turn on the heater, press the Heater button.

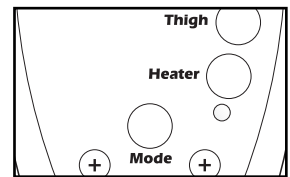

The Heater indicator will light. Press the button again when you want to turn off the heater. **Note:** When the heater is on, the maximum intensity setting of the vibrating massage action will be lower. Therefore, the intensity may decrease slightly when the heater is turned on.

Note: If no buttons on the hand control are pressed for twenty minutes, the heater will automatically turn off. To turn on the heater, follow the instructions above.

HOW TO TURN OFF THE POWER

To turn off the power, slide the power switch to the "off" position. The power indicator will darken.

HAND CONTROL TROUBLE-SHOOTING

If the hand control does not function properly, make sure that the transformer on the power cord is plugged into a 120-volt outlet. In addition, make sure that the hand control is properly connected to the massage pad (see assembly step 3 on page 5).

HOW TO REMOVE THE MASSAGE PAD FROM THE FRAME

If desired, the massage pad can be removed from the frame and used on the floor or a bed. Follow the steps below to remove the massage pad.

1. Unplug the power cord from the outlet. It is recommended that you also disconnect the power cord from the jack on the massage pad.

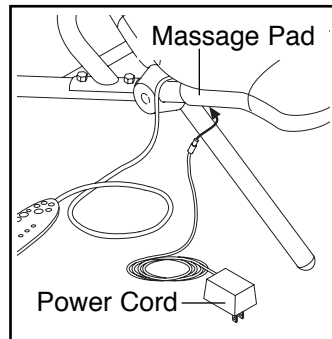

2. Next, it is recommended that you disconnect the wire harness on the hand control from the wire harness on the massage pad. To disconnect the wire harnesses, first press down the indicated small latch.

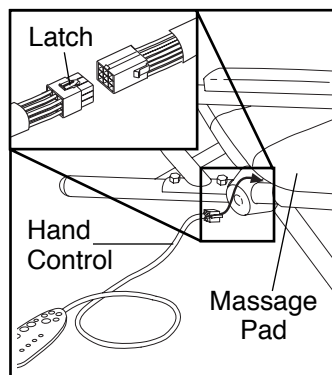

3. Fold the massage chair into the storage position. Slide the massage pad off the seat frame and the back frame. Note: There is a sleeve between the massage pad and the frame. Be careful not to remove the sleeve as you remove the massage pad.

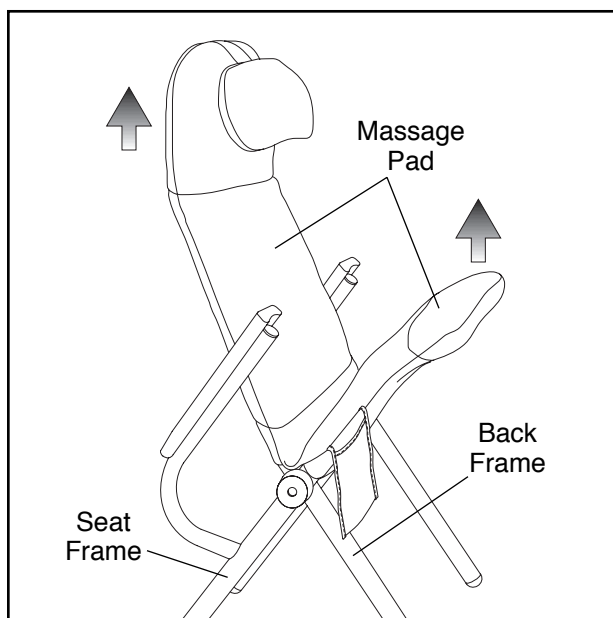

HOW TO USE THE MASSAGE PAD ON A FLOOR OR BED

After the massage pad is removed from the frame, reconnect the hand control and the power cord to the massage pad (see the drawings at the left).

Next, spread the massage pad flat on the floor or bed. If desired, pillows can be placed under the massage pad for added comfort. **WARNING: Do not place a blanket or pillow on top of the massage pad. Excessive heating can occur and cause fire, electric shock, or injury to persons.**

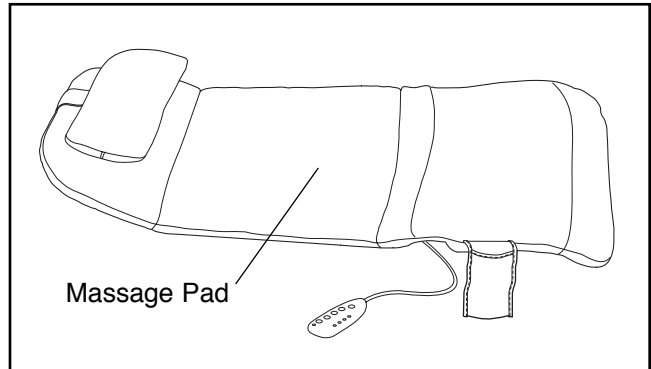

To operate the massage pad, refer to pages 6 and 7 of this manual.

HOW TO ATTACH THE MASSAGE PAD TO THE FRAME

To use the massage pad on the frame, it is recommended that you first disconnect the power cord and the hand control from the massage pad (see the drawings at upper left).

Next, fold the massage chair into the storage position. Slide the massage pad onto the frame (see the drawing at the left). Make sure that the sleeve is properly positioned between the massage pad and the frame.

Finally, reconnect the hand control and the power cord to the massage pad.

MAINTENANCE AND STORAGE

Check the massage chair periodically to make sure that all parts are properly tightened.

The massage chair can be cleaned with a low-power hand-held vacuum or a dry cloth. **IMPORTANT: Never use water or solvents to clean the massage chair.**

If the hand control does not function properly, make sure that the transformer on the power cord is plugged into a 120-volt outlet. In addition, make sure

that the hand control is properly connected to the massage pad (see assembly step 3 on page 5).

When the massage chair is not in use, it can be folded for compact storage. **IMPORTANT: Avoid sharp folds in the massage pad when storing the massage chair. Never place objects on top of the massage chair during storage.**

PART LIST—Model No. QVRX10170

R0597A

| Key No. | Qty. | Description | Key No. | Qty. | Description |
|---------|------|--------------------------|---------|------|--------------------------|
| 1 | 4 | 5/16" x 2" Carriage Bolt | 11 | 4 | 1/4" x 1 3/4" Screw |
| 2 | 2 | Arm Cap | 12 | 1 | Massage Pad |
| 3 | 2 | 5/16" x 3 3/4" Bolt | 13 | 1 | Headrest |
| 4 | 4 | 5/16" Washer | 14 | 1 | Hand Control |
| 5 | 4 | 5/16" Nylon Locknut | 15 | 1 | Back Frame |
| 6 | 4 | Frame Cap | 16 | 1 | Power Cord w/Transformer |
| 7 | 4 | Pivot Cover | 17 | 1 | Sleeve |
| 8 | 2 | Armrest | 18 | 4 | 1/4" Washer |
| 9 | 2 | Arm | 19 | 2 | 5/16" Nylon Jam Nut |
| 10 | 1 | Seat Frame | # | 1 | User's Manual |

Note: "#" indicates a non-illustrated part. Specifications are subject to change without notice. To order replacement parts, see the back cover of this manual.

EXPLODED DRAWING—Model No. QVRX10170

R0597A

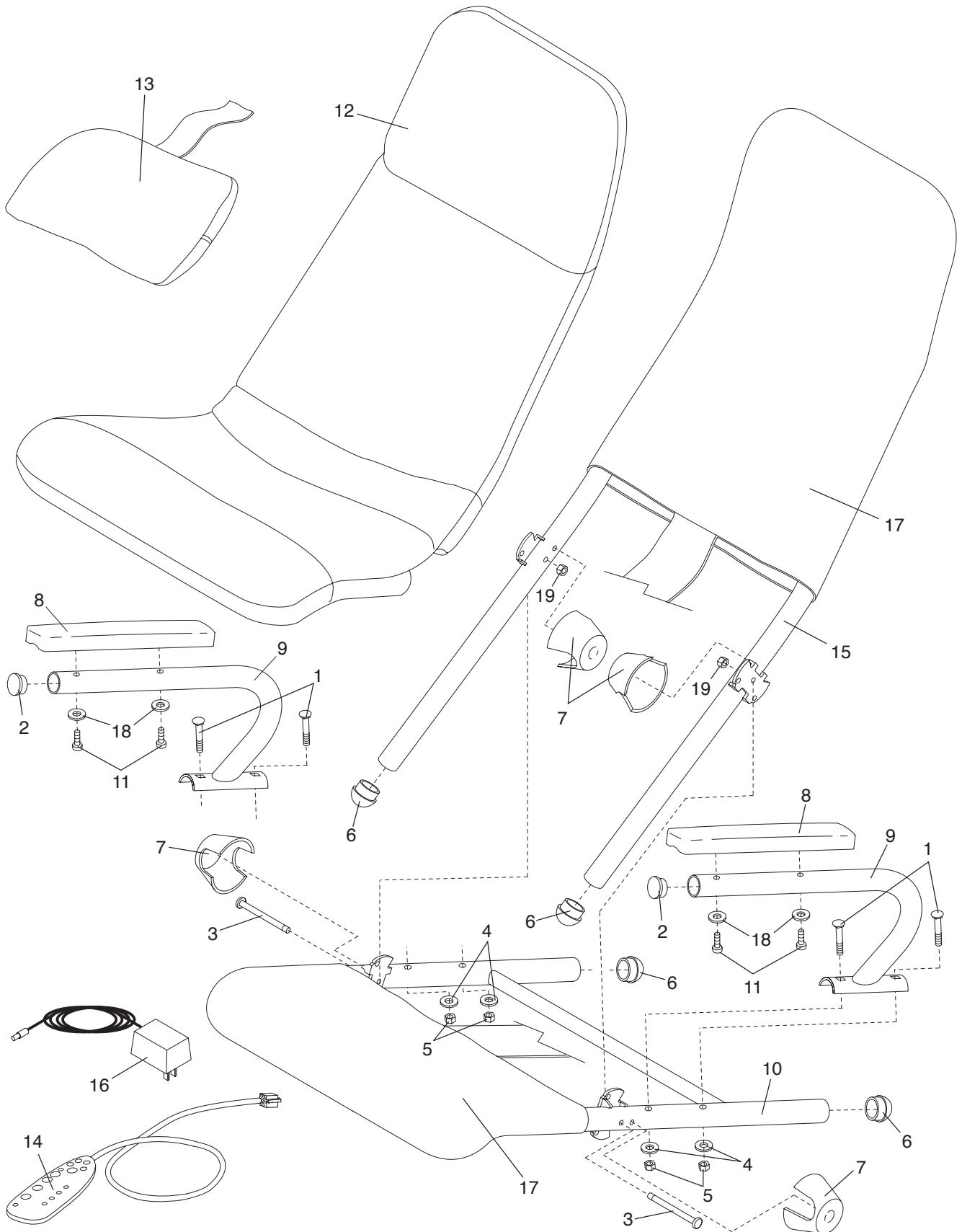

HOW TO ORDER REPLACEMENT PARTS

To order replacement parts, simply call our Customer Service Department toll-free at 1-800-999-3756, Monday through Friday, 6 a.m. until 6 p.m. Mountain Time (excluding holidays). To help us assist you, please be prepared to give the following information when calling:

1. The MODEL NUMBER of the product (QVRX10170).
2. The NAME of the product (DAYBREAK multi-zone massage chair by WESLO®).
3. The SERIAL NUMBER of the product (see the front cover of this manual).
4. The KEY NUMBER and DESCRIPTION of the desired part(s) (see the PART LIST on page 10).

WESLO® is a registered trademark of ICON Health & Fitness, Inc.

LIMITED WARRANTY

ICON Health & Fitness, Inc. (ICON), warrants this product to be free from defects in workmanship and material, under normal use and service conditions, for a period of ninety (90) days from the date of purchase. This warranty extends only to the original purchaser. ICON's obligation under this warranty is limited to replacing or repairing, at ICON's option, the product at one of its authorized service centers. All products for which warranty claim is made must be received by ICON at one of its authorized service centers with all freight and other transportation charges prepaid, accompanied by sufficient proof of purchase. All returns must be pre-authorized by ICON. This warranty does not extend to any product or damage to a product caused by or attributable to freight damage, abuse, misuse, improper or abnormal usage or repairs not provided by an ICON authorized service center, products used for commercial or rental purposes, or products used as store display models. No other warranty beyond that specifically set forth above is authorized by ICON.

ICON is not responsible or liable for indirect, special or consequential damages arising out of or in connection with the use or performance of the product or damages with respect to any economic loss, loss of property, loss of revenues or profits, loss of enjoyment or use, costs of removal, installation or other consequential damages of whatsoever nature. Some states do not allow the exclusion or limitation of incidental or consequential damages. Accordingly, the above limitation may not apply to you.

The warranty extended hereunder is in lieu of any and all other warranties and any implied warranties of merchantability or fitness for a particular purpose is limited in its scope and duration to the terms set forth herein. Some states do not allow limitations on how long an implied warranty lasts. Accordingly, the above limitation may not apply to you.

This warranty gives you specific legal rights. You may also have other rights which vary from state to state.

ICON HEALTH & FITNESS, INC., 1500 S. 1000 W., LOGAN, UT 84321-9813